



Quick guide:

How to install and commission a Fronius Smart Meter 50kA-3

* 3-phase Energy Meter

43,0001,1478 Fronius Smart Meter 50kA-3

White Paper

© Fronius International

Version 1.0/2016

Fronius reserves all rights, in particular rights of reproduction, distribution and translation.

No part of this work may be reproduced in any way without the written consent of Fronius. It must not be saved, edited, reproduced or distributed using any electrical or electronic system.

You are hereby reminded that the information published in this document, despite exercising the greatest of care in its preparation, is subject to change and that neither the author nor Fronius can accept any legal liability. Gender-specific wording refers equally to female and male form.

1 Scope of use

A smart meter helps to keep track of the energy flow, consumption and production values. By adding a smart meter you are able to identify and control energy saving potentials and take action in order to increase your self-consumption rate. This can mean e.g. changing your behaviours like manually shifting your peak consumption times, integrate energy management / consumer control or even energy storage systems. If an energy storage system in form of a battery is added to an installation a smart meter is mandatory.

The Fronius Smart Meter 50 kA-3 is an energy meter which can be used with external current transducers. For this reason, it's easy to retrofit in electrical installations where grid connections can't be modified. The Fronius Smart Meter is an energy meter that works in conjunction with the Fronius Datamanager 2.0. It has to be connected to the Fronius Datamanager 2.0 which comes built-in to all Fronius SnapINverter (Fronius Galvo / Primo / Symo / Eco), and can be retrofitted into all other Fronius inverters. Using a ModBus RTU / RS485 communication protocol, the Fronius Smart Meter can be utilised to monitor load and energy data by measuring current, voltage, energy, reactive power and apparent power in total or per phase.

This document describes how to do install and setup the Fronius Smart Meter 50kA-3, based on the example of a 3-phase electrical grid.

1.1 Requirements

/ Important! The Fronius Smart Meter cannot be used in combination with the Fronius Datamanager Version 1.

/ The Fronius Datamanager 2.0 requires a software version of V3.3.6-13 or greater.

/ The Fronius Datamanager 2.0 needs to be set up before executing the meter settings. For information on how to set up the Fronius Datamanager please see the Fronius inverter or the Fronius Datamanager manual (for Fronius Galvo/Symo/Primo/Eco): http://www.fronius.com/cps/rde/xbcr/SID-DBD64F5C-18F6818F/fronius_australia/42_0426_0191_EA_388899_snapshot.pdf

1.2 Where to put the Fronius Smart Meter

In ordinary residential installations, in most cases the Fronius Smart Meter will be put into the feed-in path (Graphic 1). If the PV system is connected to a sub board it's most likely to achieve the load measurement by having the meter in the feed-in path. Alternatively, if only a specific consumer branch should be measured, the Fronius Smart Meter can also be put into the "consumption path".

Feed-in point

In this setting the solar generation passes through the meter as well as the site load.

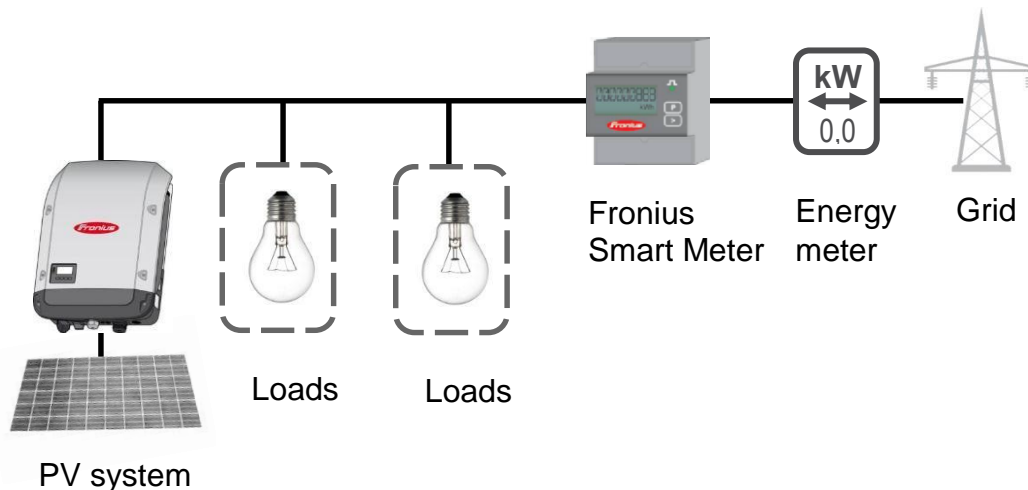

Graphic 1: Position of the Fronius Smart Meter

2 INSTALLATION AND COMMISSIONING

2.1 Wiring of the Fronius Smart Meter 50kA-3

In this paper the wiring for 3-phase grids with Neutral (3N3E) is described. The Fronius Smart Meter 50kA-3 can also be used with 1-phase or 2-phase grid systems. For more information concerning these grid types, please check out the installation manual

http://www.fronius.com/cps/rde/xbcr/SID-C3A503DB-9EB48230/fronius_international/42_0410_2169_734957_snapshot.pdf

The **installation procedure** in this document is as follows:

1. Mount the Fronius Smart Meter on the DIN rail in your switchboard
2. Build up the communication between Fronius Smart Meter and Fronius Datamanager 2.0
3. Hook the external current transducers to each AC phase of the grid
4. Connect the cables for the voltage and fusing
5. Program the transmission ratio into the Fronius Smart Meter
6. Activate the Fronius Smart Meter in the Fronius Datamanager 2.0 web interface

The following circuit diagram gives an overview about the AC and communication cabling:

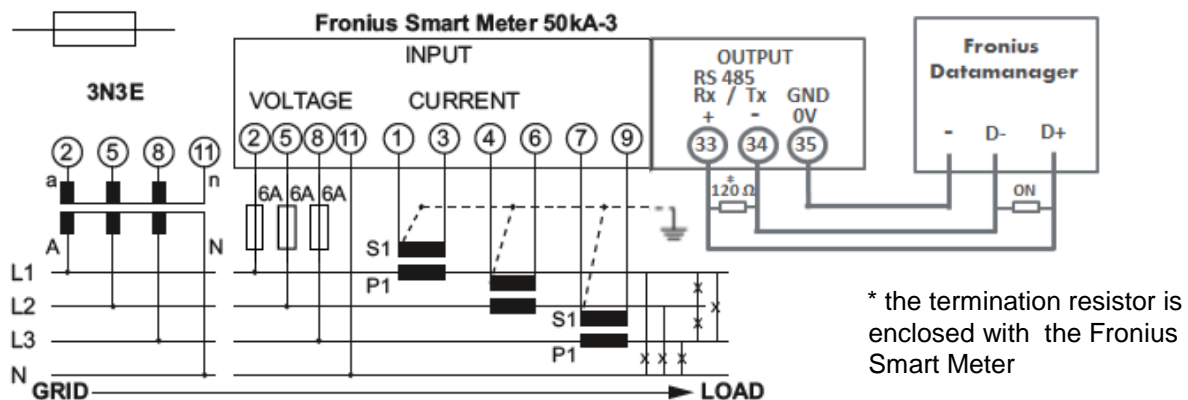

Graphic 2: Circuit diagram of Fronius Smart Meter 50kA-3

2.2 Communication with the Fronius Datamanager 2.0

To set up the communication between inverter and Fronius Smart Meter the RS485 interface with Modbus RTU protocol is used. That means to connect three wires only. For a proper bidirectional communication flow (D+ / D-) it is mandatory to terminate the bus line with 120 Ω resistors. This is realised by a dip-switch on the Fronius Datamanager 2.0 and an external termination resistor which has to be connected between Fronius Smart Meter connectors 33 and 34 manually. The external resistor is delivered with the Fronius Smart Meter.

Please note:

/ Wiring between Fronius Smart meter and inverter should use a CAT5 or CAT6 cable. **Important:** To be compliant with the AS3000 standards, it is recommended to have the CAT5/CAT6 cable in a heat shrink tubing (probably 10mm) when it enters the switchboard part or alternatively use a 240V rated CAT5/CAT6 cable – Clipsal CBUS cable.

/ Connection is a data line for Modbus RTU / RS485 using screw terminals on the meter

/ Connection is a data line for Modbus RTU / RS485 using screw terminals on the Fronius Smart Meter

/ You can use the cable colours of your choice. Please make sure the cables for bidirectional communication “D+”

/ “D-“are a twisted pair!

/ Maximum distance of the cable: 300 m (980 feet)

The Fronius **Datamanager 2.0** has got an orange connector plug, where the cables for the Fronius Smart Meter have to be connected.

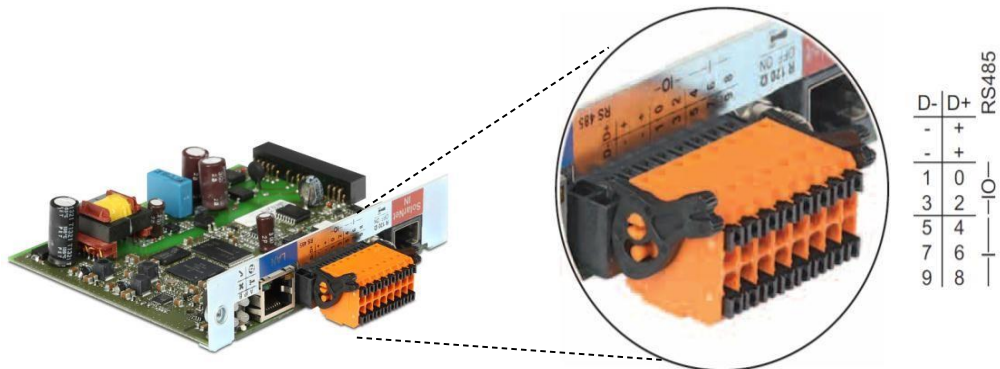

Graphic 3: Fronius Datamanager 2.0 - Connectors

Modbus termination switch on the Fronius Datamanager 2.0: The internal bus termination 120-Ohm resistance (for Modbus RTU) needs to be switched to *ON* to be activated.

On the Fronius Smart Meter, the external resistor has to be put between the connectors 33 and 34 like shown in *graphic 4* and *graphic 5*.



Graphic 4: Modbus connectors and termination

2.3 Connection of external current transducers to the Fronius Smart Meter 50kA-3

The Fronius Smart Meter 50kA-3 is designed for the operation with external current transducers with a secondary current of 1 A or 5 A. You can select the transducer of your choice, Fronius is not offering transducers to order! Please note that your selected type has to be in line with the selection criteria outlined in the document “Selection criteria for a current converter for the Fronius Smart Meter 50kA-3”

[http://www.fronius.com/cps/rde/xbcr/SID-C3A503DB-](http://www.fronius.com/cps/rde/xbcr/SID-C3A503DB-9EB48230/fronius_international/SE_IS_Selection_criteria_for_current_converter_EN_735004_snapshot.pdf)

[9EB48230/fronius_international/SE_IS_Selection_criteria_for_current_converter_EN_735004_snapshot.pdf](http://www.fronius.com/cps/rde/xbcr/SID-C3A503DB-9EB48230/fronius_international/SE_IS_Selection_criteria_for_current_converter_EN_735004_snapshot.pdf)

One of the most important things is the **right order of the cable connection** from the current transducer to the Fronius Smart Meter. They have on the primary “P” side an inlet marked “P1” and an outlet marked “P2”. Make sure that you wire the phase cable in the direction from “P1” to “P2” through the aperture. Also, connect the cables from the current converters secondary connectors “S1” and “S2” to the Fronius Smart Meter in the right order as shown in *graphic 5*.

Current transducer on phase “L1”: “S1” to connector “1”, “S2” to connector “3”.

Current transducer on phase “L2”: “S1” to connector “4”, “S2” to connector “6”.

Current transducer on phase “L3”: “S1” to connector “7”, “S2” to connector “9”.

Additionally, there is the possibility to connect a grounding cable to the external current transducers, if required.

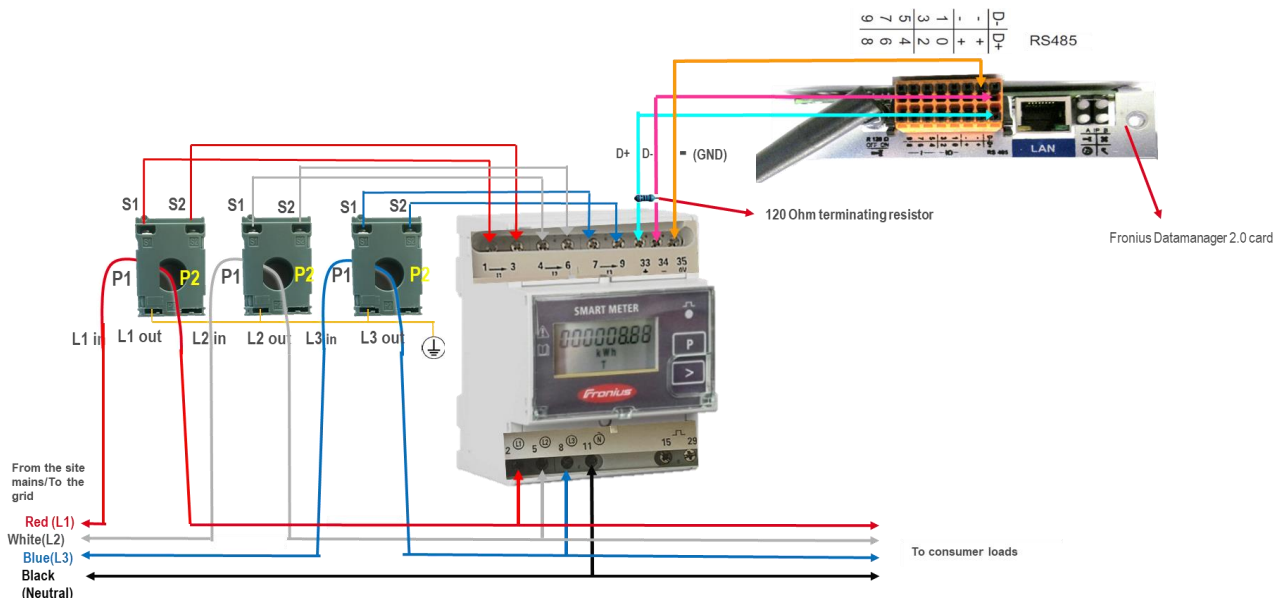

Graphic 5: Overview of cable connections to Fronius Smart Meter 50kA-3

When connecting the cables for voltage measurement to the bottom terminal on clamps “2”, “5”, and “8”, please make sure that each of them is fused with 6 Amp fuses. Neutral can be connected on clamp “11”.

For communication connect the CAT5 / CAT6 twisted pair cables on “D+” → “33”, “D-” → “34” and “-” → “35”. Don’t forget the termination as described in 2.2 above.

2.4 Programming the transmission ratio into the Fronius Smart Meter.

After you have done the commissioning of the Fronius Smart Meter it is mandatory to program the transmission ratio into the Fronius Smart Meter. Depending on the transmission ratio, indicated in the tech specs of the current converter, this factor has to be set into the software of the Fronius Smart Meter in order to display the correct values.

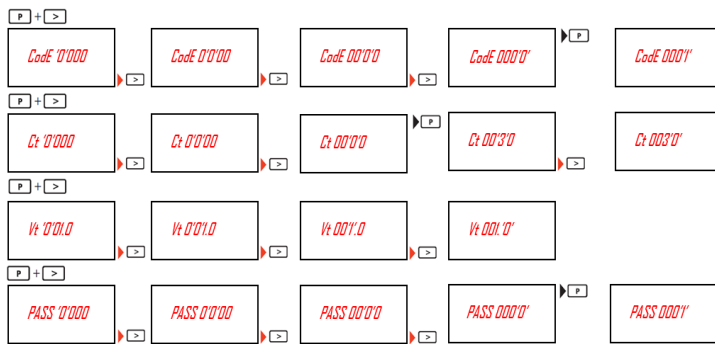

1. Press P and > and enter the password: 0001
2. Set the transmission ratio for the CT, which is given by Primary current: Secondary current. For example if the primary current is 150A and secondary current is 5A, then the CT ratio is 30
3. If you use voltage transducers then set the transmission ratio for the VT's
4. After setting the transmission ratios, save changes by exiting the menu.

2.5 Activate the Fronius Smart Meter on the Fronius Datamanager 2.0 web interface

The Fronius Smart Meter can be activated on the web interface of the Fronius Datamanager 2.0 as shown in the following screenshots. Activate the hotspot on the inverter display or connect to the Datamanager 2.0 via Ethernet cable. Connect to the hotspot "Fronius_240.xxxxx" with your PC or smart device and enter the Password "12345678". Open a web browser and enter <http://datamanager> or the IP "192.168.250.181" in the address line.

For details of establishing the connection and adjusting the preferences, see the Fronius Datamanager 2.0 operation manual.

https://www.fronius.com/cps/rde/xbcr/SID-04B1F325-9E012E35/fronius_international/42_0426_0191_EA_388899_snapshot.pdf

On the Fronius Datamanager 2.0 web interface select „Settings“

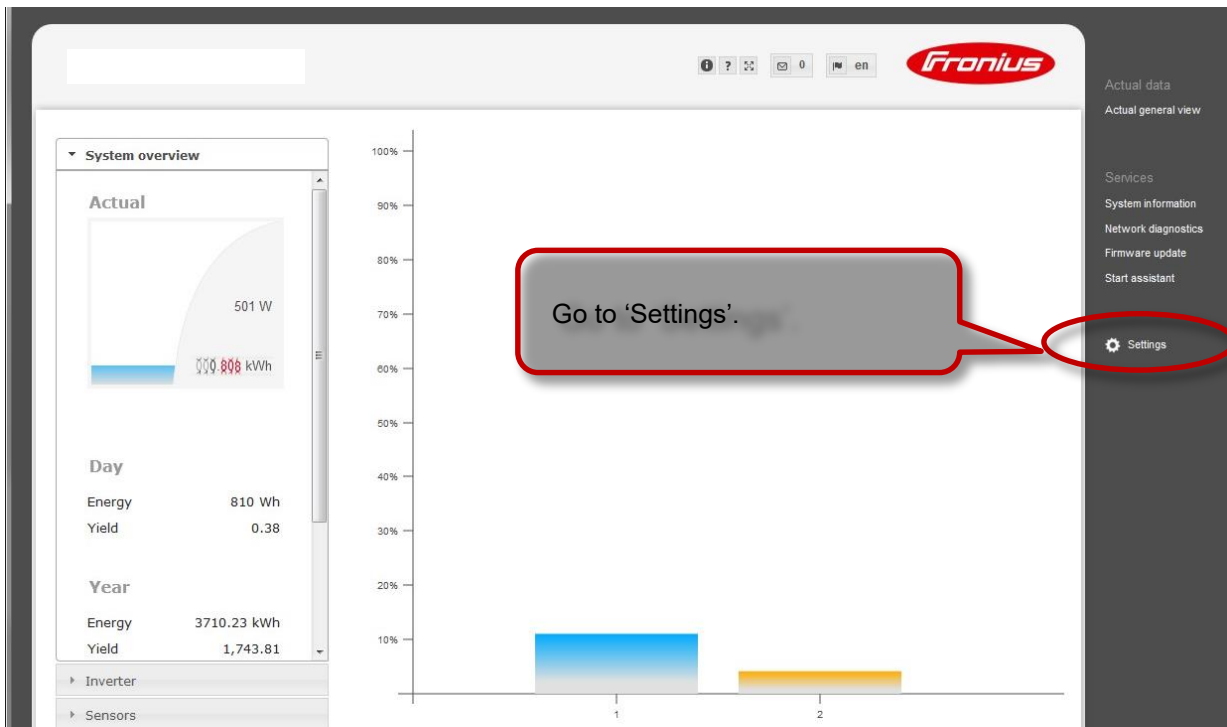

/ Before it is possible to enter the *METER* settings a service password is required. If no service password has been set, it needs to be created first.

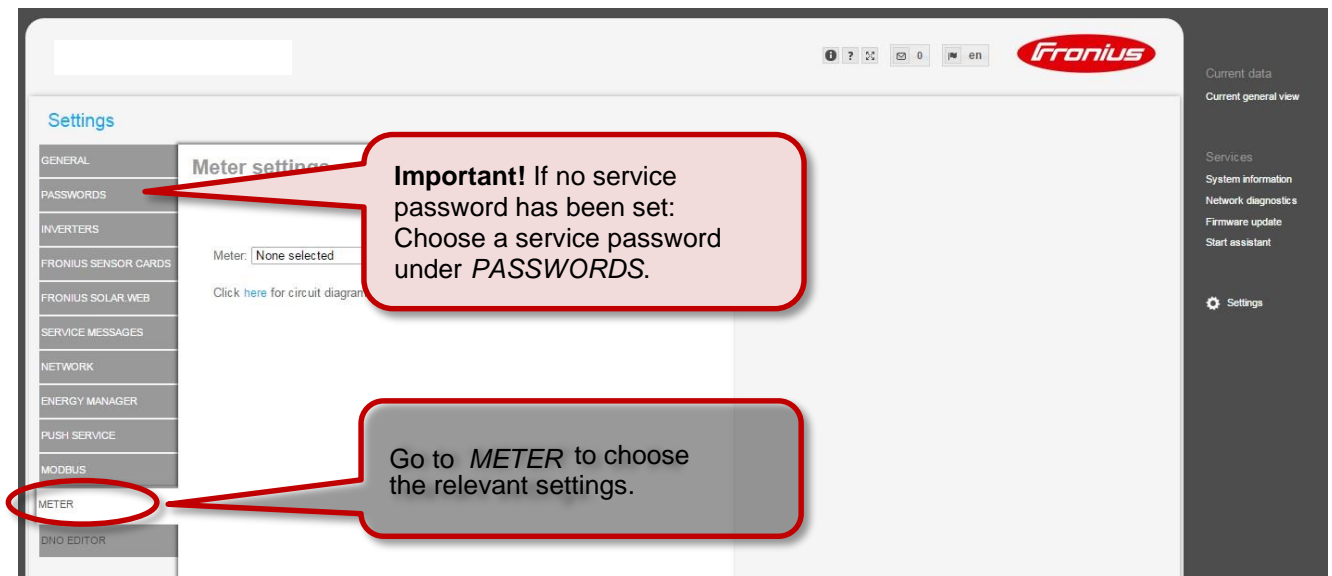

/ Choose the type of meter.

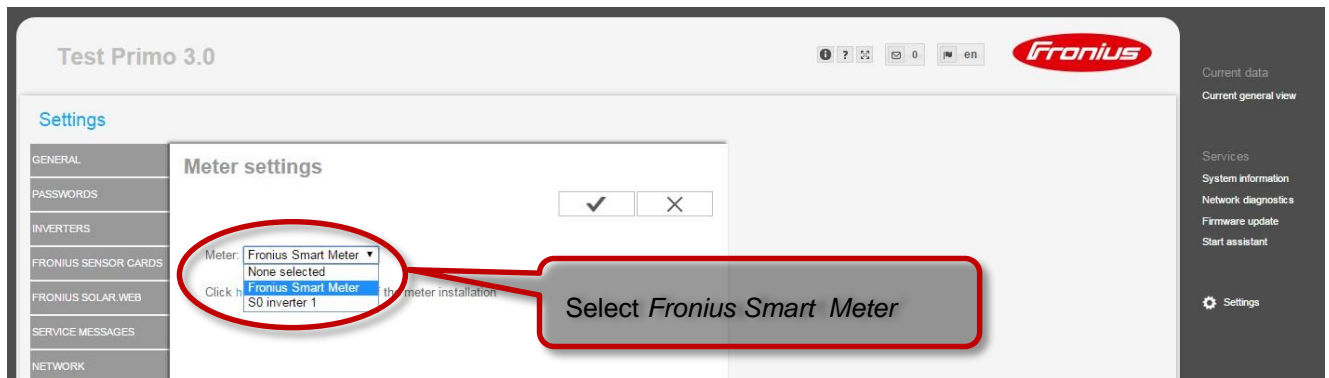

/ Choose the installation location.

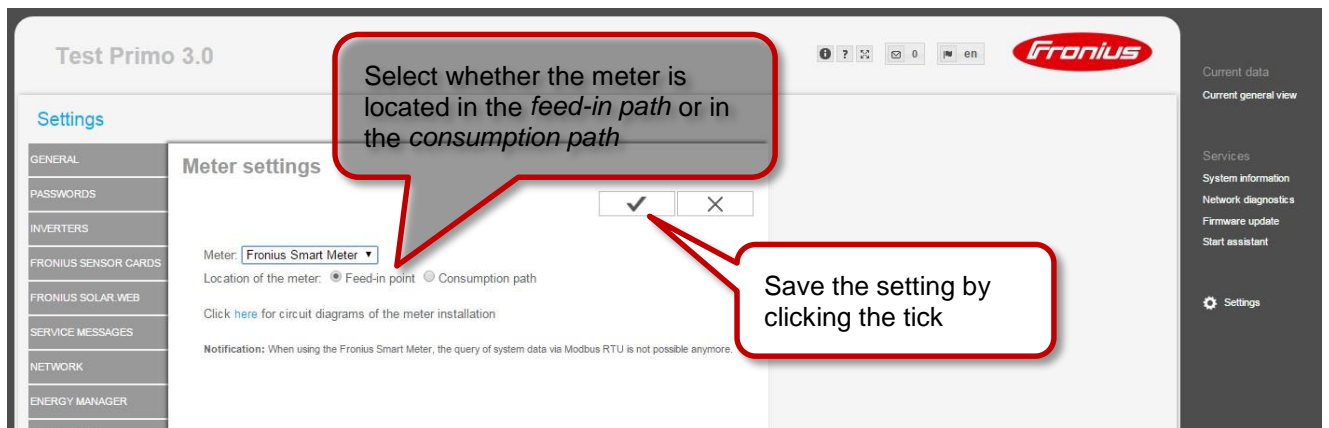

For further explanation on feed-in path and consumption path see chapter 1.2 *Where to put the Fronius Smart Meter*

/ The meter is activated once you get the following message. Click OK.



Done!

For more information on the Fronius Datamanager 2.0 please see the operating instructions on the Fronius website under *Solar Energy / Products / System monitoring / Datalogging / Fronius Datamanager 2.0* or click:

http://www.fronius.com/cps/rde/xbcr/SID-4E4E93D8-20335A81/fronius_international/42_0426_0191_EA_388899_snapshot.pdf